



PMK-V363

---

**INSTALLATION MANUAL**  
**For Passenger Vans**

# Thank you for purchasing the EchoMaster Ford Transit HD Camera Package



## Table of Contents

**Page 4** -HD Mirror Monitor / Harness

**Page 7** - FTV-CAM-EXT-HAR

**Page 12** - HD Camera

## WHAT'S INCLUDED:



- PMM-V363 HD Mirror Monitor
- CAM-V363 HD Camera with Vehicle Specific Housing
- PMK-FTV-HAR Vehicle Specific Mirror Monitor Harness
- FTV-CAM-EXT-HAR Camera Extension Harness
- Hardware Pack



## TOOLS NEEDED:

---

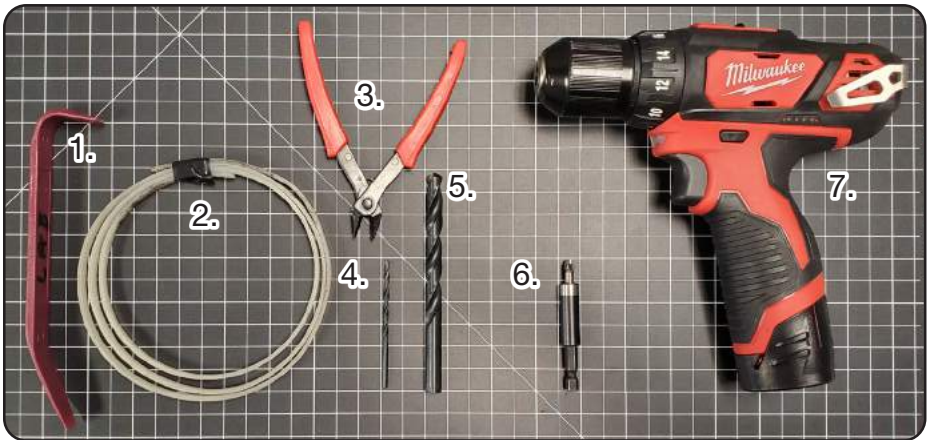

1. Plastic Trim Tool
2. Wire Fishing Tool
3. Diagonal Cutters
4. 7/64" Drill Bit or Unibit
5. 3/8" Drill Bit or Unibit
6. Phillips Bit with Bit Holder
7. Drill

PMK-V363

# INSTALLATION GUIDE

## FULL VIEW MIRROR / HARNESS FITTING INSTRUCTIONS

### STEP 1:

Remove the dome light housing using a plastic trim tool to push forward and release the two clips on the rear side of the front dome light panel and pop down and pull towards the rear of the vehicle. Reference the pictures below for the locations of the clips.



If the vehicle is equipped with the overhead tray, the dome light housing will be slightly different. It may be removed in a similar fashion.

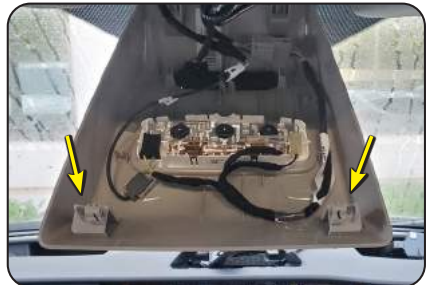

## STEP 2:

Using a plastic trim tool, remove the shroud from behind where the rear view mirror would be to gain access to the wiring. Remove the center cap from the mirror shroud.

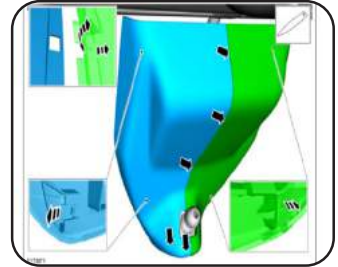

## STEP 3:

After removing the mirror shroud, locate the 12 pin in-line connector (A). Connect the 12 pin T-Harness in-line at this location and route the mirror side of the harness down and towards the mirror location (B).

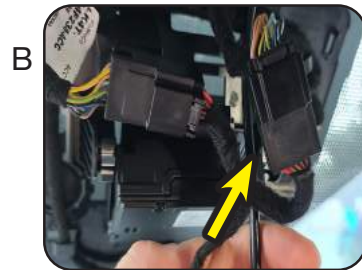

## STEP 4:

Route the Mini-Din connector end of the harness from behind the mirror shroud to the dome light opening exposed in step 1. Fasten the remainder of the harness behind the mirror shroud to the factory wiring using the supplied wire ties.

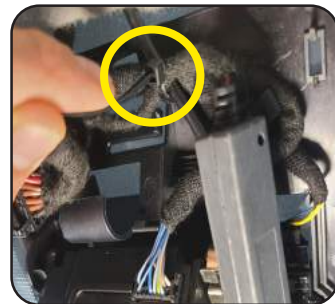
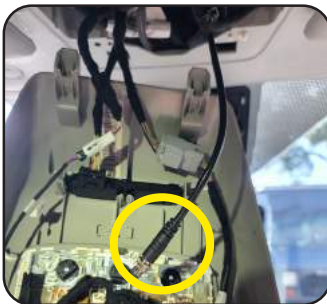

## STEP 5:

Install the HD Full-View mirror by starting with the top of the mirror mount at the 10 o'clock position and place it on the twist lock mount. Twist the base of the mirror until the top of the mirror is at the 12 o'clock position. You should feel the alignment tab click into place.



## STEP 6:

Route the end of the cable with the white mirror connector down to the back of the mirror along the right hand side of the mirror shroud area. This is where the inline filter (Outlined in yellow) will be secured (A). Install the mirror connector cover (B), then plug the connector into the back of the mirror (C).

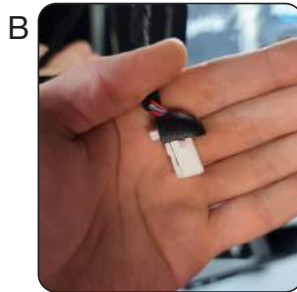
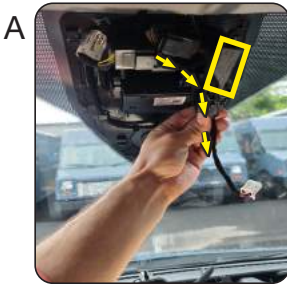

## STEP 7:

Reinstall the shroud behind the mirror. At this time, ensure that the flip dimmer located on the bottom of the mirror is flipped forward towards the passenger compartment (rear of the vehicle).



# FTV-CAM-EXT-HAR FITTING INSTRUCTIONS

## Harness Routing Overview



Camera Connector



Monitor Connector

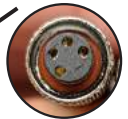

# STEP 1:

To properly route the extension harness, we will need to remove the rear-most portion of the headliner. Begin by removing the pillar covers under the front and on each side of this portion of the headliner. There are 3 pressure clips holding the pillar cover in place. Shown below is the left hand side, removal of the right hand side is similar (A). After both pillar covers are removed, proceed with using a nylon panel removal tool to remove the Upper Striker Trim covers for the rear door (B).

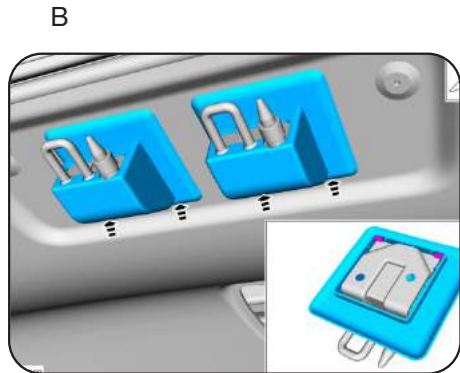
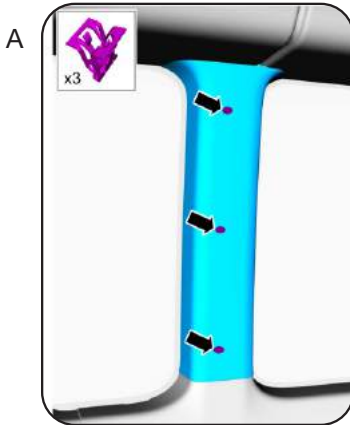

# STEP 2:

Next, remove the 2 push clips circled below (A). Then, use a panel removal tool to pop out the large overhead cargo lamp and disconnect the harness (B).

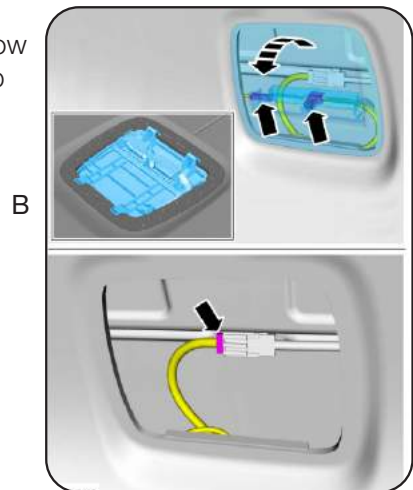



## STEP 3:

Continue by pulling the weatherstrip down and position it aside (Highlighted in yellow below). Then use a push clip removal tool to remove the remaining clips near the rear of the headliner piece. Then, release the clips holding the headliner to the roof and remove the headliner piece (Highlighted in blue below) from the vehicle.

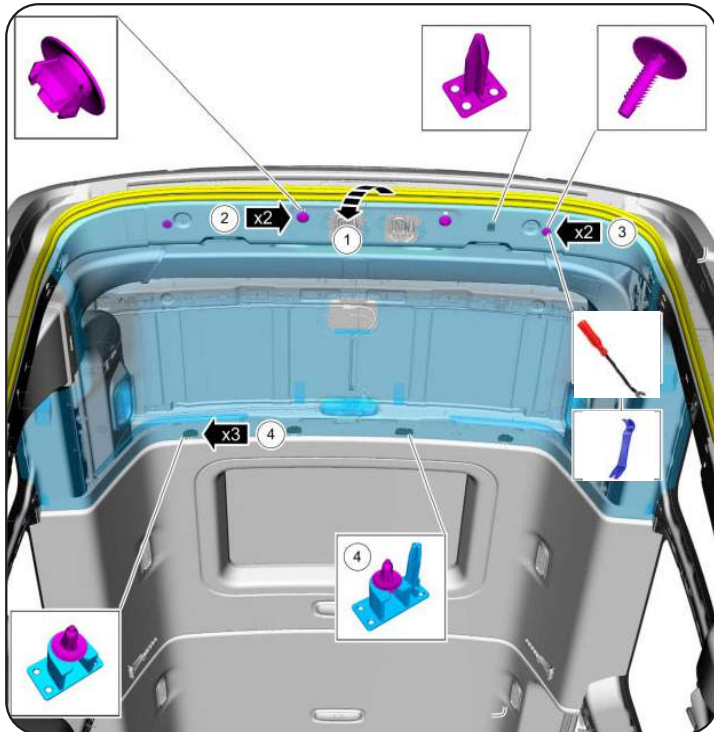

## STEP 4:

Continue with routing the extension harness. It will be routed from the rear of the vehicle to the front. To start, route the monitor connector end of the extension harness over the rear air duct, then route it towards the headliner going to the front of the vehicle.

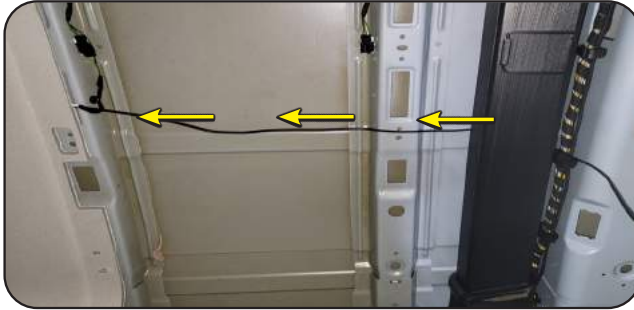

## STEP 5:

Pop out the 2 overhead interior lights in the middle of the vehicle to facilitate routing the extension harness. Using a wire fishing tool, route the harness to the dome light opening exposed previously. This can be easily done by using the wire fishing tool to jump from each opening exposed by removing the overhead interior lights to the next and finally to the dome light opening.



Interior  
Lights

## STEP 6:

With the monitor connector extension harness end in the dome light opening, make the connection to the mirror power harness installed previously and still hanging in the dome light opening. With the connection made, pull the extra harness back towards the rear of the vehicle until taut. Then, secure the harness to the overhead interior lamp wiring with zip ties in each of the openings exposed by popping out the overhead lights.



## STEP 7:

With the monitor connection now made and the extension harness secured in place, take the camera connector end and position it to be routed into the small rectangular opening below the air duct. This is where we will be routing and connecting the camera wiring. Any excess length of the extension harness can be bundled and secured to the factory wiring behind the air duct.

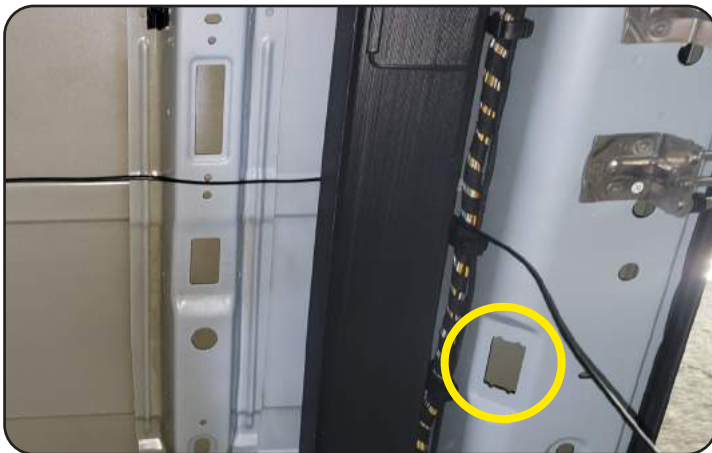

## HD CAMERA FITTING INSTRUCTIONS

### STEP 1:

Using the supplied template, line it up with the right edge of the CHMSL. The bottom lip of the template should wrap around the top of the rear door frame. You may need to pull down the rubber door seal to allow the template to seat properly into place. Place the template as shown below.

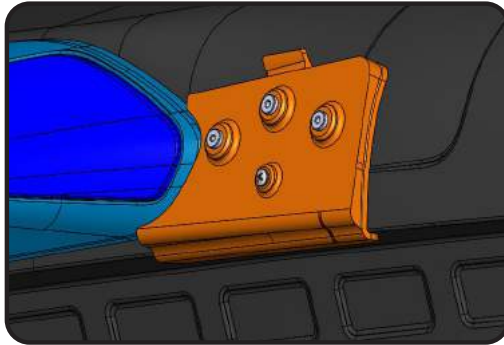

### STEP 2:

Using a standard  $7/64$ " drill bit, drill the three holes needed using the drill guides in the template to mount the camera. Using a unibit, drill the top hole out to  $7/16$ " using the diagram below for sizing reference.

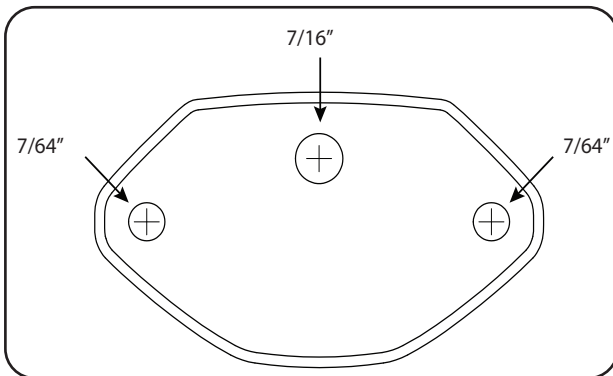

## STEP 3:

Route the camera cable into the vehicle and secure the camera to the vehicle with the supplied screws. Be sure to place the screw caps over the screws when finished.



## STEP 4:

Connect the camera to the camera extension harness and secure any excess wire within the vehicle body.





**Phone – 866-931-8021**

E-Mail – [support@aampglobal.com](mailto:support@aampglobal.com)



EchoMaster is a Power Brand of AAMP Global

**[EchoMaster.com](http://EchoMaster.com)**

REV. DC0722